



DISPENSER

---

THE  
BRIGHT  
CHOICE

---

PRODUCT  
CATALOGUE

gfl  
SKIN CARE



# CONTENT

*Cartridge /*

## PUMP SYSTEM

-  - **CYLINDER** *pag 07*  
*P 400*
-  - **ROUND** *pag 16*  
*P 350*
-  - **SQUARE** *pag 22*  
*P 500*

## SWINGING SYSTEM

-  - **SWING ME** *pag 29*  
*HMR 341*
-  - **OVOSOAP** *pag 36*  
*OVR 380*

## BRACKET SYSTEM

-  - **CYSOAP** *pag 41*  
*PCYR 360*
-  - **SQUEEZABLE** *pag 48*  
*PDSR 330*

## SHELF SYSTEM

-  - **SHELFSOAP** *pag 55*  
*FSS 300*

*refillable /*

- PUMP SYSTEM** *pag 62*  
*P 400 / P 350 / P 500*

# CARTRIDGES: THE B•RIGHT CHOICE

**Cartridge systems, non refillable dispensers that can't be refilled.**

The Cartridge dispensers' range includes a wide selection of models, all aesthetically and functionally designed with a particular attention to detail and with a "green" soul. All made from recycled plastic, they can be recycled again and again to reduce the waste, following the circular economy principles.

Attention to the product design means also taking great care of all **safety features and economical aspects**, to offer our guests a product that can be at the same time safe and extremely convenient for the hospitality world.

GREEN SOUL

>100% 100%

Post consumer plastic Recyclable plastic

## 60% LESS PLASTIC

The ratio of plastic used per millilitre is much lower than the plastic used in a single use bottle. In comparison to a 30 ml bottle, the amount of plastic used is 60% less.



## LOW CARBON FOOTPRINT

we save 87%\* of CO2 emissions for the complete plastic resin production used in our recycled bottles.

\* This data is available due to a LCA calculation on our post consumer PET resin compared to a virgin resin.



## OCEAN PLASTIC AVAILABLE

Turning ocean waste into bottles



## POST CONSUMER PLASTIC IN THE CIRCULAR ECONOMY

AFTER USE, THE RECYCLABLE PLASTIC IS SORTED AND SENT TO SPECIALIZED FACILITIES WHERE IT IS BROKEN DOWN INTO REUSABLE PLASTIC FLAKES.

THESE FLAKES, KNOWN AS POST-CONSUMER PLASTIC, CAN BE REFORMED AND REUSED INDEFINITELY WITH CAREFUL MANUFACTURING.

THIS PROCESS IS ENDLESS: NEW PLASTIC CAN BE OBTAINED FROM OLD PLASTIC IN A CIRCULAR ECONOMY MODEL THAT AIMS TO CREATE VALUE FROM WASTE.

BENEFIT FOR HOTELS



Reduction of risk of theft, thanks to holder with key.



Packaging waste is typically reduced by 60%.



Up to 85% reduction of labour cost, no need for refilling sealed dispensers!



Labels wrap the bottles to leave only the band necessary to check the level of the product.



Time saving for cleaning team.



Easier management of amenities stock, less space needed.

BENEFIT FOR GUESTS



## PRODUCTS INTEGRITY MAXIMUM HYGIENE

Tamper-proof closures (caps and pumps) guaranteed the integrity of products for the final user and the maximum hygiene (not contaminated by handling operations).



## BATCH NUMBER

With the BATCH number it will be possible to provide all the bulk's documentation in case of any problems (intolerances, allergies, irritations, etc.).

The guests can be sure to use the bulk revision written on the label.



Avoid refilling error.



Guests are not limited to a 30ml based on 2 guests per room.



*Cartridge /*  
**PUMP SYSTEM**

# CYLINDER

P400  
380 ml e 12,84 us fl.oz.

An evergreen choice for hotels and public areas. Extremely flexible, thanks to a wide range of accessories it can be placed almost everywhere.



Zero Km product - 100% Made in Italy

### Use and Display

Can be displayed on a wall with two different Holders, as well as being available in a free standing option.

### Hygiene guaranteed

Tamper-proof pump guarantees the guest that it has not been contaminated by handling operations or another guest.

### Anti-theft system

Thanks to the cavity on the bottom, the bottle does not come off the bracket.

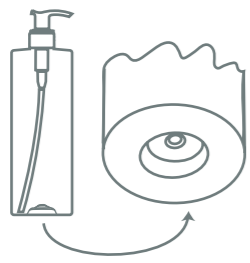

### No product dispersion

Assembled with a closed pump, it must be opened

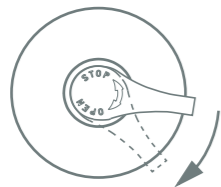

GFL ranges with P400

THE RERUM NATURA

PRIJA

osmè  
organic

GENEVA GUILD

Certified cosmetics available



## Components Materials & colours

### Pumps



100% recyclable

Transparent

Black

White

### Pump dosage

1.2 cc - dosage optimized for individual use

### Bottles

100% recycled PET  
100% recyclable



transparent



white



frosted



brown  
on demand

### Use

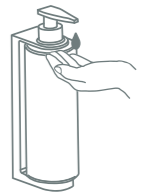

## HOLDERS

### Pump dispenser holder

in ABS material 100% recyclable



anti-theft, accessible with housekeeping key.

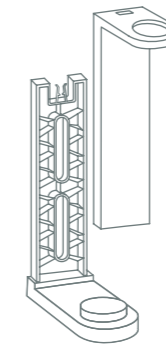

Screws



Double sided Tape



white



black



chrome silver\*

\*recyclability is not guaranteed due to the chrome plating, check with your country how to dispose of it.

### Stainless steel holder

in Stainless steel material available single, double and triple.



anti-theft, accessible with housekeeping key.

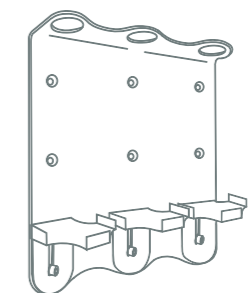
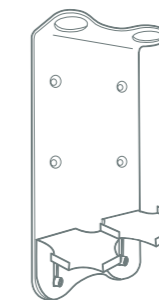

Screws



polished stainless steel



THE RERUM NATURA  
**THE BODY WASH**  
a citrus ritual body cleanser  
enhanced with pleasant  
guaiac wood notes  
IL GEL DUCIA - LE GEL  
DOUCHE - DAS DUSCHGEL  
EL GEL DE DUCHA  
O GEL DE BANHO  
300 ml e 12.84 fl.oz.

THE RERUM NATURA  
**THE SHAMPOO**  
a caring lavender shampoo  
enhanced with a bitter  
orange leaf note  
LO SHAMPOO  
LE SHAMPOONG  
DAS HAARSHAMPOO  
EL CHAMPU - O CHAMPU  
300 ml e 12.84 fl.oz.

THE RERUM NATURA  
**THE HAIR  
CONDITIONER**  
a zesty lemongrass  
conditioner enhanced with  
relaxing notes of vetiver  
IL BALSAMO - L'APRES  
SHAMPOING  
DE HAARSPLENG  
EL ACONDICIONADOR  
O ALCIADOR  
300 ml e 12.84 fl.oz.







cartridge / pump system

# SQUARE

P500  
480 ml e 16,23 us fl.oz.

Modern minimalistic design  
with the characteristics of a  
squared shaped bottle.



Zero Km product - Made in Italy

### Use and Display

Can be displayed on a wall with two different Holders, as well as being available in a free standing option.

### Hygiene guaranteed

Tamper-proof pump guarantees the guest that it has not been contaminated by handling operations or another guest.

### Anti-theft system

Thanks to the cavity on the bottom, the bottle does not come off the bracket.

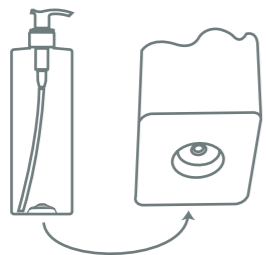

### No product dispersion

Assembled with a closed pump, it must be opened



### Oriented pump

when opened the pump will be oriented in line with the front product

GFL ranges with P500

ANYAH  
ECO SPA TREATMENT

GUEST LOVE  
• established •  
1995

TRAVELERAC

Certified cosmetics available



## Components Materials & colours

### Pumps



100% recyclable

Transparent

Black

White

### Bottles

100% recycled PET  
100% recyclable



transparent grey

black

white

brown  
on demand

### Pump dosage

1.2 cc - dosage optimized  
for individual use

### Use



## HOLDERS

### Pump dispenser holder

in ABS material 100% recyclable

anti-theft, accessible with  
housekeeping key.

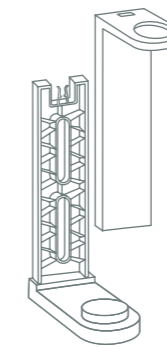

Screws

Double sided Tape



white

black

chrome silver \*

\*recyclability is not guaranteed due to the chrome plating, check with your country how to dispose of it.

### Stainless steel holder

in Stainless steel material  
available single, double and triple.

anti-theft, accessible with  
housekeeping key.

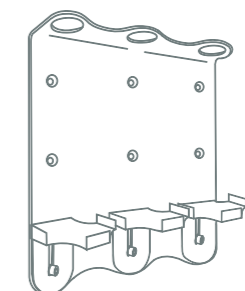
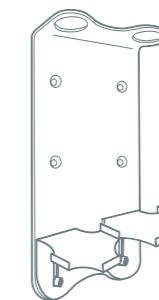

Screws

polished  
stainless steel

GUEST LOVE  
• established •  
1995





# ROUND

P350  
370 ml e 12,51 us fl.oz.

*The brand new dispenser shape, which resembles an apothecary style bottle. designed to offer a wider range of pump bottles.*



**Zero Km product - Made in Italy**

**Use and Display**

Can be displayed on a wall with two different Holders, as well as being available in a free standing option.

**Hygiene guaranteed**

Tamper-proof pump guarantees the guest that it has not been contaminated by handling operations or another guest.

**Anti-theft system**

Thanks to the cavity on the bottom, the bottle does not come off the bracket.

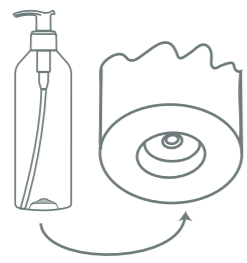

**No product dispersion**

Assembled with a closed pump, it must be opened

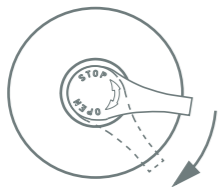

## Components Materials & colours

**Pumps**

100% recyclable



Transparent Black White

**Bottles**

100% recycled PET  
100% recyclable



transparent green brown on demand

**Pump dosage**

1.2 cc - dosage optimized for individual use

**Use**



## HOLDERS

**Pump dispenser holder**

in ABS material 100% recyclable

 anti-theft, accessible with housekeeping key.

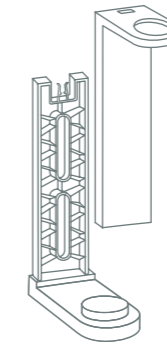

white black chrome silver\*

\*recyclability is not guaranteed due to the chrome plating, check with your country how to dispose of it.

**Stainless steel holder**

in Stainless steel material available single, double and triple.

 anti-theft, accessible with housekeeping key.

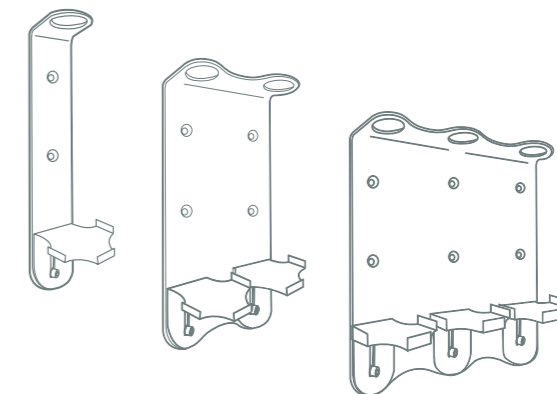

Screws polished stainless steel







*Cartridge /*  
**SWINGING SYSTEM**

# SWING ME

HMR

340 ml e 11,49 us fl.oz.

*Practical, essential and optimized in every detail. And yes, it swings... to offer the best simplicity of use.*



**Zero Km product - Bottle Made in Italy  
Cap made in Eu**

**Use and Display**

Can be displayed on a wall with a holder that can be installed with screw or double sided tape.  
With a double level band: it is possible for the housekeeper to check the remaining quantity of product.

**Hygiene guaranteed**

the closed system guarantees the guest that it has not been contaminated by handling operations or another guest.

**Anti-theft system**

The holder can only be opened with a specific key.

**No product dispersion**

Drip free seal.



## Components Materials & colours

**Bottles**

93% recycled PE  
100% recyclable



white blue grey

**average dosage amount**

2.8 ml per dosage

**Valve-cover**

100% recyclable



white blue grey

**Use**

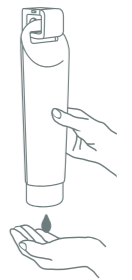

## Holders

**Screws holder**

in ABS material 100% recyclable

anti-theft, accessible with housekeeping key.



Screws



white blue grey

**Adhesive holder**

in ABS material 100% recyclable

anti-theft, accessible with housekeeping key.

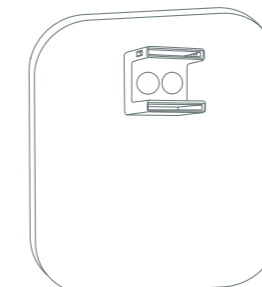

Double sided Tape



white blue grey







ANYAH  
ECO SPA TREATMENT

**YOUR RESTITUTION**  
daily conditioning formula containing  
an amlino acid derivative. In perfect  
affinity with the hair.  
CONDITIONING SHAMPOO /  
SHAMPOO & BALSAMO /  
SHAMPOING & BAUME  
SHAMPOO & HAARSPÜLUNG /  
CHAMPU Y ACONDICIONADOR

340 ml e 11,50 fl.oz.



let's make the environment smile.  
BOTTLE MADE OF 95% RECYCLED PLASTIC



ANYAH  
ECO SPA TREATMENT

**YOUR SMOOTHNESS**  
formulated with a precursor  
of hyaluronic acid  
BODY WASH / GEL DOCCIA /  
GEL DOUCHE / DUSCHGEL /  
GEL DE DUCHA

340 ml e 11,50 fl.oz.



let's make the environment smile.  
BOTTLE MADE OF 95% RECYCLED PLASTIC



ANYAH  
ECO SPA TREATMENT

**YOUR HAIR CARE**  
enriched with shea butter  
and organic sunflower seed oil  
CONDITIONER / BALSAMO  
APRES-SHAMPOING /  
HAARSPÜLUNG /  
ACONDICIONADOR

340 ml e 11,50 fl.oz.



let's make the environment smile.  
BOTTLE MADE OF 95% RECYCLED PLASTIC

# OVOSOAP

OVR380

380 ml e 12,84 us fl.oz.

*Curvy and elegant in design.  
The Ovosoap consists of a refined shape with high capacity.  
Suitable for contemporary and luxury environments.*



Zero Km product - Bottle Made in Italy  
Cap made in Eu

### Use and Display

Can be displayed on the wall with a holder that can be installed with screw or double sided tape.

Available in semi-transparent or an opaque white bottle with a double level band.

Artwork is printed directly on bottle.

### Hygiene guaranteed

the closed system guarantees the guest that it has not been contaminated by handling operations or another guest.

### Anti-theft system

The holder can only be opened with a specific key.

### No product dispersion

Drip free seal.

GFL ranges with OVR



Soapify.

## Components Materials & colours

### Bottles

100% recyclable



white  
with double-level band



semi-transparent

average dosage amount

2.8 ml per dosage

### Valve-cover

100% recyclable



white

### Use



## HOLDERS

### Screws holder

in ABS material 100% recyclable

anti-theft, accessible with housekeeping key.



Screws



white



blue grey

### Adhesive holder

in ABS material 100% recyclable

anti-theft, accessible with housekeeping key.

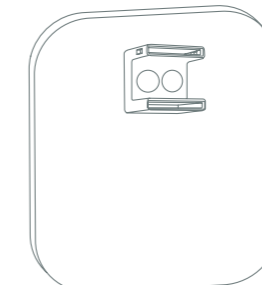

Double sided Tape



white



blue grey

GUEST LOVE  
• established •  
1995



Soapify.



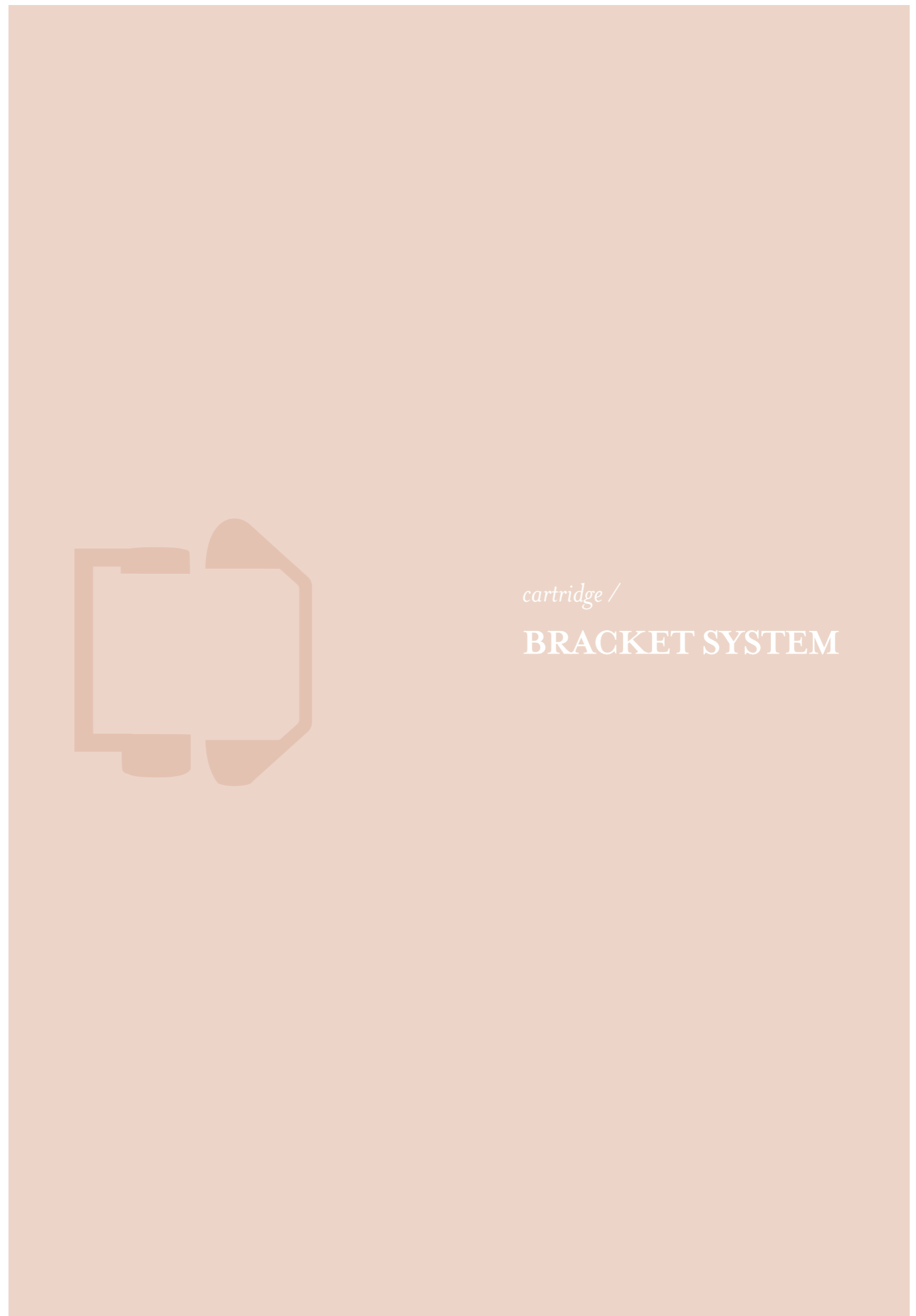

cartridge /  
BRACKET SYSTEM

# CYSOAP

P360  
360 ml e 12,17 us fl.oz.

*Minimalistic and contemporary in style. Thanks to its cleverly designed assembling kit, this wall dispenser is very easy to use. Its cylindrical shape makes it perfectly optimized.*



**Zero Km product - Bottle Made in Italy  
Cap made in Eu**

**Use and Display**

Can be displayed on the wall with an ABS material that is 100% recyclable.

**Hygiene guaranteed**

the closed system guarantees the guest that it has not been contaminated by handling operations or another guest.

**Anti-theft system**

The holder can only be opened with a specific key.

The cap is made of 50% recycled plastic

**No product dispersion**

Drip free seal.

GFL ranges with Cysoap THE RERUM NATURA  
PRIJA  
GENEVA GREEN  
hopal  
travelcare essentials

Certified cosmetics available



## Components Materials & colours

**Bottles**

100% recycled PET  
100% recyclable



**average dosage amount**

2.8 ml per dosage

**Use**

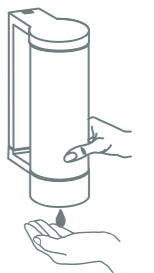

## Holder

**Wall Bracket**

in ABS material 100% recyclable

anti-theft, accessible with housekeeping key.

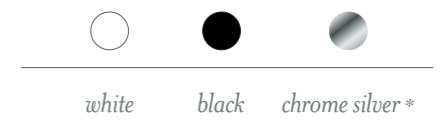
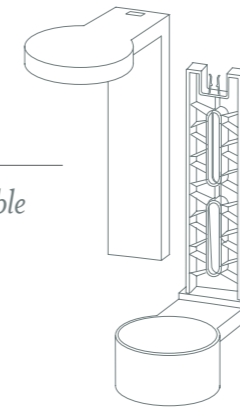

\*recyclability is not guaranteed due to the chrome plating, check with your country how to dispose of it.



PRIJA





Cartridge / bracket system

# SQUEEZABLE

PDSR330  
330 ml e 11,15 us fl.oz.

*Friendly but delicate, through in-depth ergonomic studies, this product has been designed to best meet the demand of convenience and has made it particularly pleasant to the eye and touch.*



Zero Km product - Bottle Made in Italy  
Cap made in Eu

### Use and Display

Trasparent matt dispenser or white dispenser with double level band, with double level band, so the housekeeper can check the quantity of product left.

### Hygiene guaranteed

the closed system guarantees the guest that it has not been contaminated by handling operations or another guest.

### Anti-theft system

The holder can only be opened with a specific key.

### No product dispersion

Drip free seal.

GFL ranges with PDSR

TRAVELERAC



GENEVA GUILD

## Components Materials & colours

### Bottles

100% recycled PET  
100% recyclable



### average dosage amount

2.8 ml per dosage

### Use

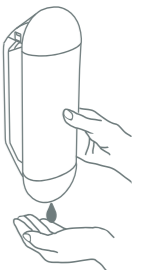

### Holders

#### Wall bracket

in ABS material 100% recyclable



anti-theft, accessible with housekeeping key.

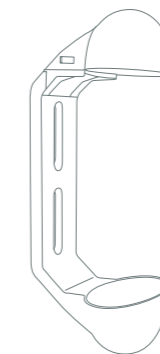

\*recyclability is not guaranteed due to the chrome plating, check with your country how to dispose of it.







cartridge /  
SHELF SYSTEM

design by  
ps+a  
ludovica + roberto palomba

# SHELF SOAP

FSS

300 ml e 10,14 us fl.oz.

*A unique, innovative and modern style, yet robust and functional. Thanks to the elegant design and the practical storage shelf this dispenser suits any environment perfectly.*

Zero Km product – Bottle Made in Italy  
Cap made in Eu

### Use and Display

Can be displayed on a wall with two styles of holder that can be installed with screws.  
With a double level band: it is possible for the housekeeper to check the remaining quantity of product.

### Hygiene guaranteed

the closed system guarantees the guest that it has not been contaminated by handling operations or another guest.

### Anti-theft system

The holder can only be opened with a specific key.

### No product dispersion

Drip free seal.



## Components Materials & colours

### Bottles

94% recycled PE  
100% recyclable



white

### Bottle average consumption

1 x month per room

### Use

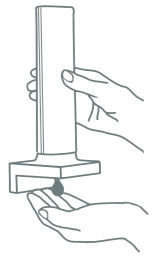

### Holder

#### Screws holder – Short

in ABS material 100% recyclable



anti-theft, accessible with housekeeping key.

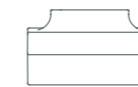

Screws



white



black



gunmetal gray\*

#### Screws holder – Long

in ABS material 100% recyclable



anti-theft, accessible with housekeeping key.



Screws



white



black



gunmetal gray\*

\*recyclability is not guaranteed due to the chrome plating, check with your country how to dispose of it.



Play and match!

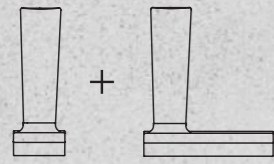

short long

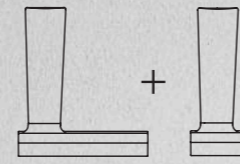

long short

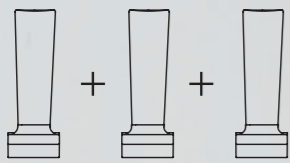
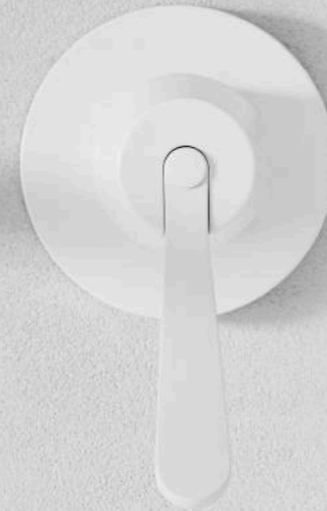

short short short

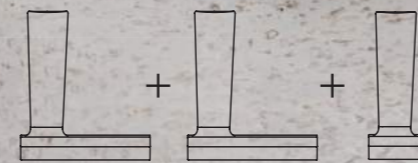

long long short

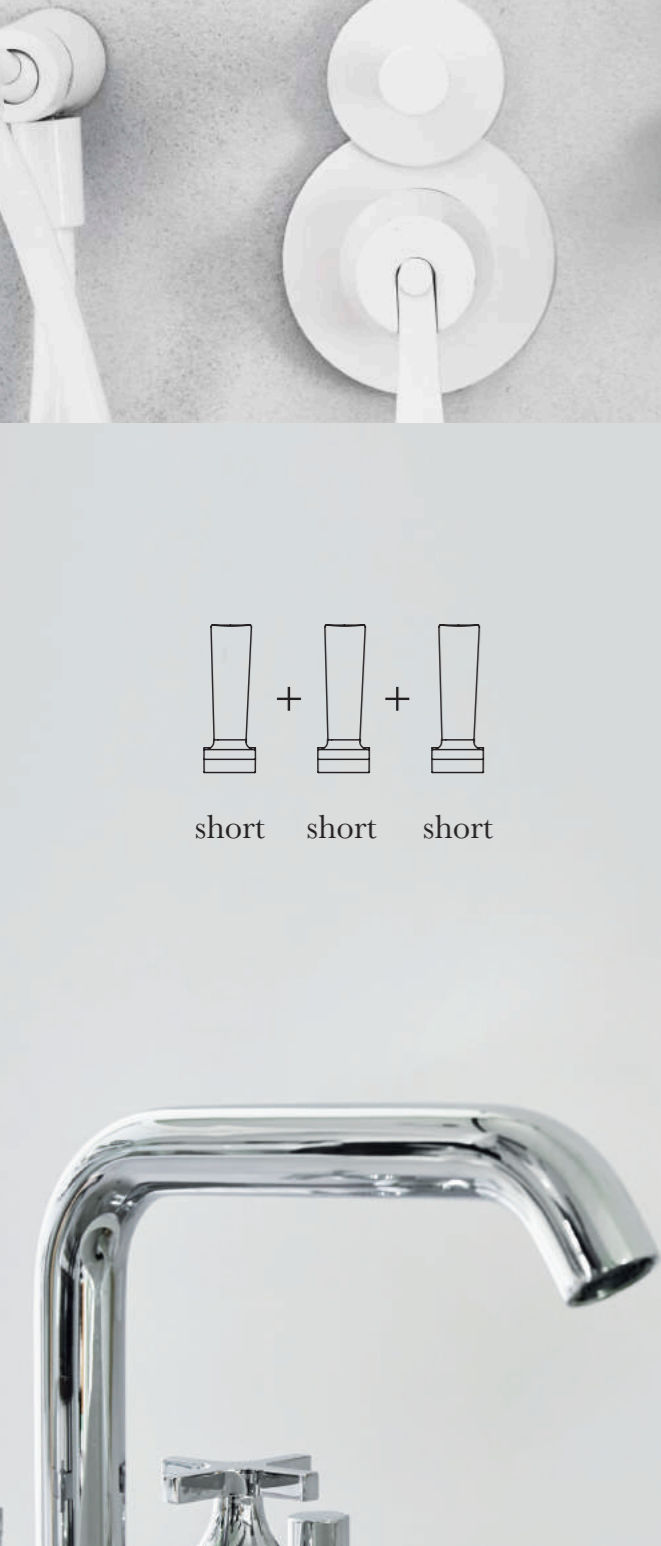

# REFILLABLE

## Refillable systems: dispensers with removable pump.

a limited selection of our non-refillable pump dispensers as shown before are also available in a refillable version. As with the non-refillable bottles the refillable ones are made from recycled post consumer PET; a new anti-theft bracket system is in development in order to guarantee that the product is only handled by the appropriate staff member.

3L tanks are available for refilling.

### CYLINDER

P400  
380 ml e 12,84 us fl.oz.



### SQUARE

P500  
480 ml e 16,23 us fl.oz.



### ROUND

P350  
370 ml e 12,51 us fl.oz.



### Components Materials & colours

All the options offered for non-refillable bottles, pumps and holders are also available in the refillable version.

### GFL ranges with refillable system

THE RERUM NATURA

PRIJA

osmè  
organic

GENEVA GUILD

GENEVA GREEN

• ANYAH  
ECO SPA TREATMENT

GUEST LOVE  
• established •  
1995







## DISPENSER \_THE BRIGHT CHOICE

specially designed by  
the creative team at GFL

December 2019

Special thanks to Agape,  
for their wonderful location  
[www.agapedesign.it](http://www.agapedesign.it)

GFL SA  
Via Sorengo 1, (CH)  
6900 Lugano

T +41(0)91 9607500  
F +41(0)91 9607599  
[info@gflamenities.com](mailto:info@gflamenities.com)  
[www.gflamenities.com](http://www.gflamenities.com)

GFL USA Inc.  
81 Prospect Street  
Brooklyn, NY 11201, USA

T +1 (718) 414-2554  
[info@gflamenities.com](mailto:info@gflamenities.com)  
[www.gflamenities.com](http://www.gflamenities.com)

GFL Middle East Cosmetics Trading LLC  
ESPADA business center  
Office #17, PO BOX 282556,  
502, 5th Floor, Rasis building  
Al Barsha 1, Dubai - UAE

T +971 4 315 98 14  
[info@gflamenities.com](mailto:info@gflamenities.com)  
[www.gflamenities.com](http://www.gflamenities.com)